



NISSAN

JUKE

TYPE: F16, 5-door SUV
(2019 -)



Innovation that excites

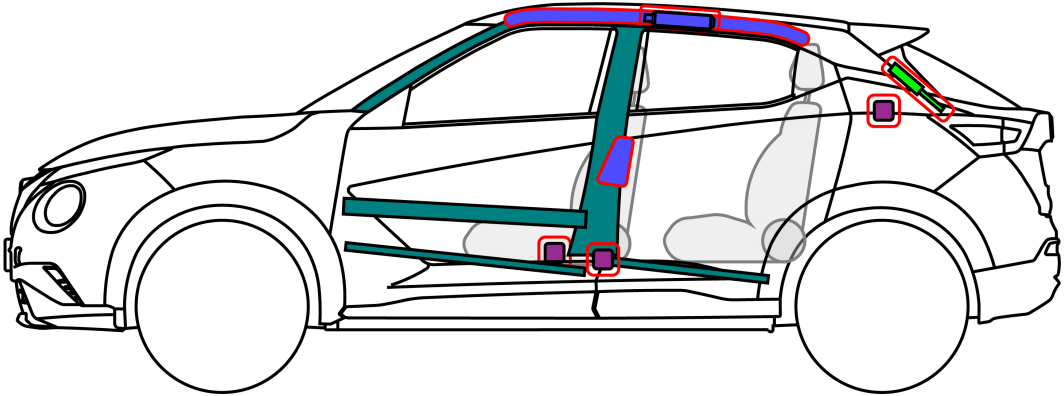
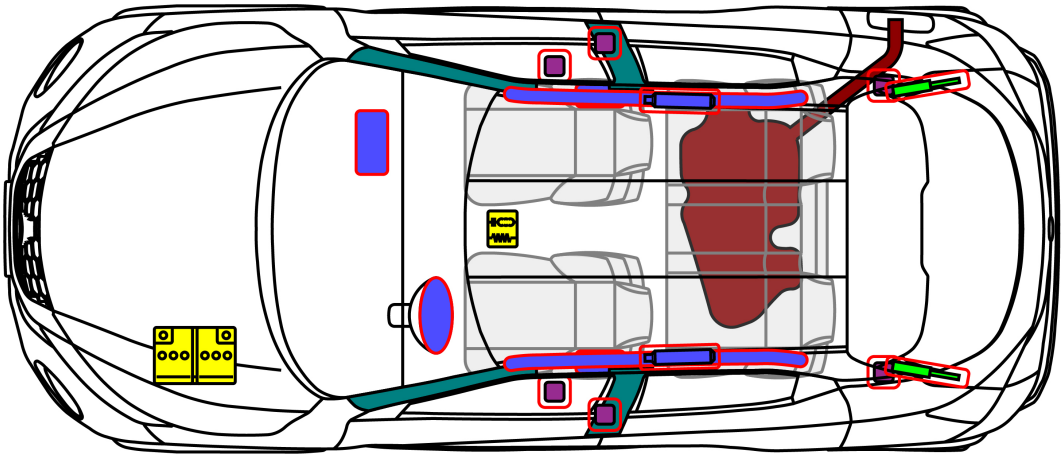

	Airbag		Stored gas inflator		Seat belt pretensioner		SRS control unit		Pedestrian protection active system
	Automatic rollover protection system		Gas strut / Preloaded spring		High strength zone		Zone requiring special attention		
	Battery low voltage		Ultra-capacitor, low voltage		Fuel tank		Gas tank		Safety valve
	Battery pack, high voltage		High voltage power cable / component		High voltage device that disconnects High voltage		Fuse box disabling high voltage		High voltage ultra-capacitor,
	Fuel tank content Gasoline / Ethanol								

1. Identification / recognition

Model



Fuel cap



Brand



2. Immobilization / stabilization / lifting

Immobilize vehicle:

1. Block wheels
2. For automatic transmission select the P (park) position
3. Set parking brake
4. Press start/stop button



Lifting points

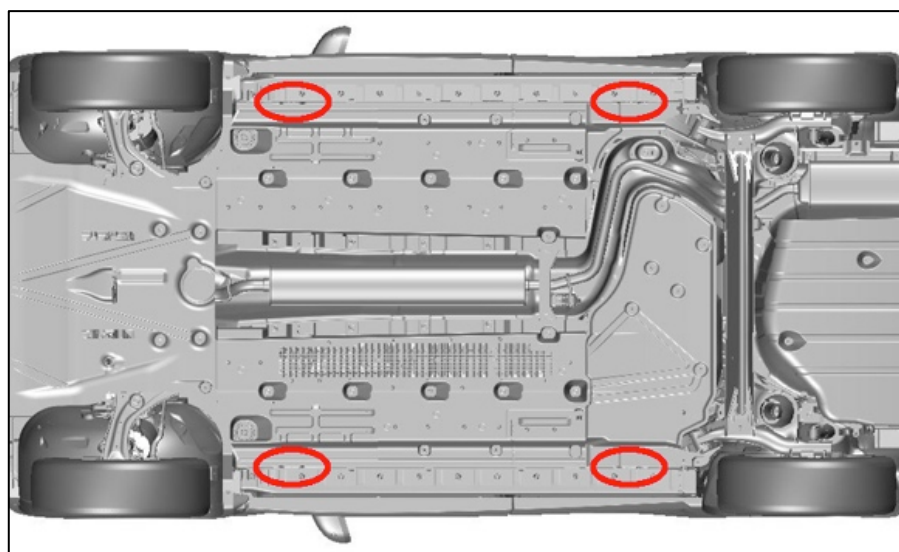

3. Disable direct hazards / safety regulations

Access to the engine compartment



Disconnect the 12 Volts battery

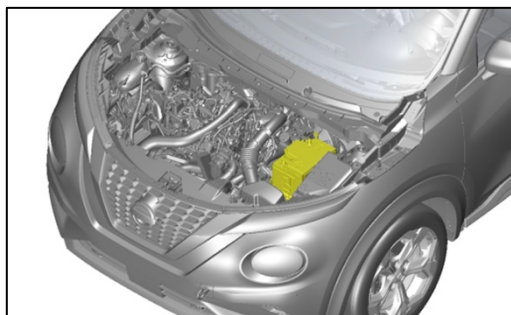
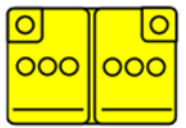

1. Switch off the ignition
2. Disconnect the negative terminal (-)
3. Disconnect the positive terminal (+)



ALWAYS WEAR APPROPRIATE PERSONAL PROTECTIVE EQUIPMENT (PPE).

4. Access to the occupants

High strength steel in body

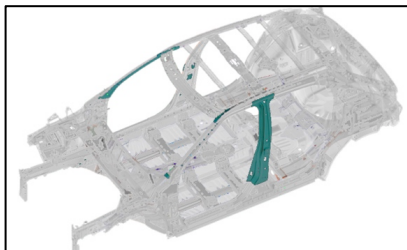

High strength steel in door

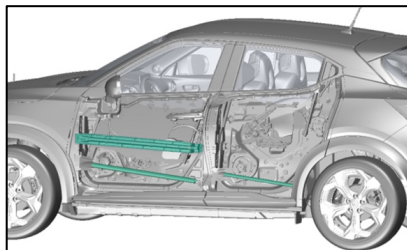

Steering column adjustment



Seat adjustment











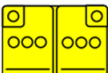

Glass types:

- A. Laminated glass.
- B. Tempered glass.



5. Stored energy / liquids / gases / solids

	12V	 
	R-1234yf 450 ±25 g	   
	46 L	 

6. In case of fire

 **USE WATER**

 **GAS STRUT, RISK OF MISSILE EFFECT**

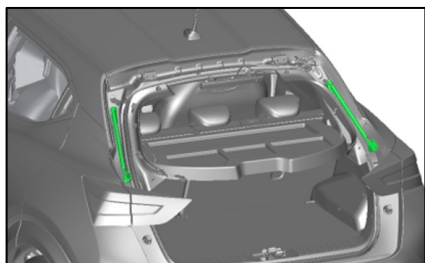

8. Towing / transportation / storage

Recovery hook storage



Location front hook









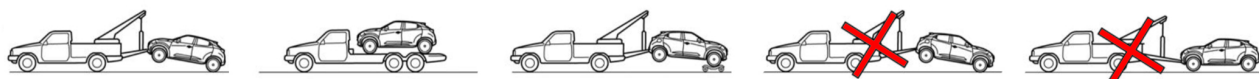



Location rear hook



Towing precautions



10. Explanation of pictograms used

	General warning sign		Flammable
	Warning; low temperature		Hazardous to the human health
	Air-conditioning component		Explosive
	Hybrid Electric Vehicle on fuel of liquid gr. 2		Corrosives
	Bonnet		Use water to extinguish the fire